

mod. "Polaris"

NOTE DISEGNO: tutti i particolari non quotati sono puramente indicativi; tolleranze prodotto +/-2mm

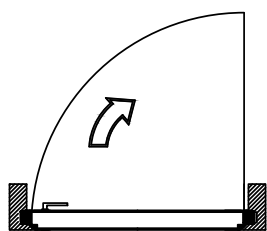

impinge dreapta

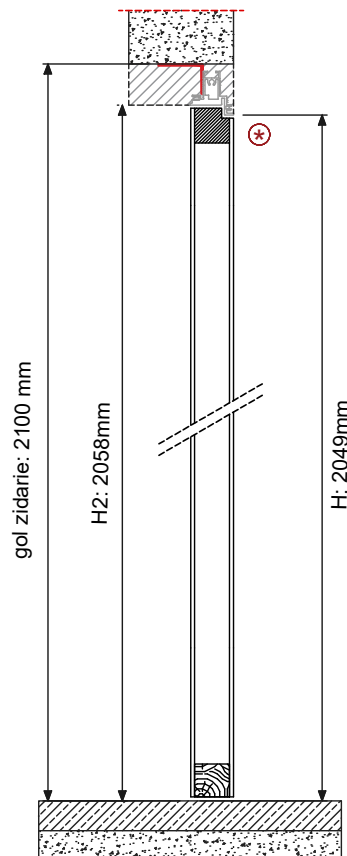
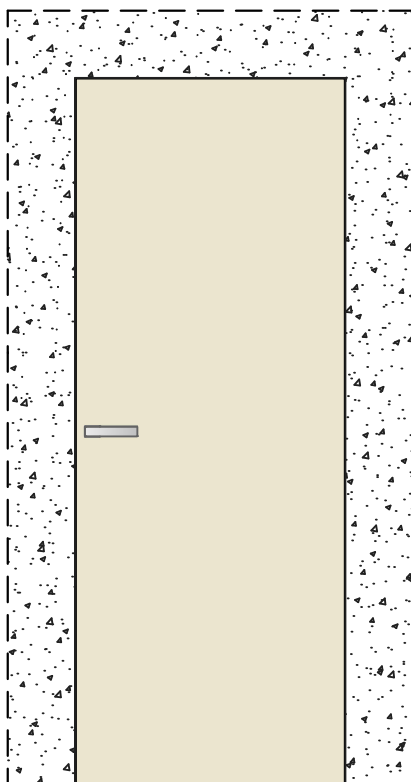
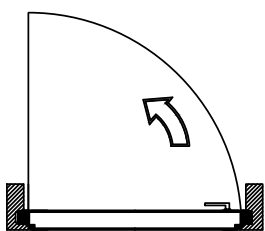

impinge stanga

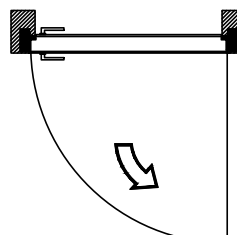

trage dreapta

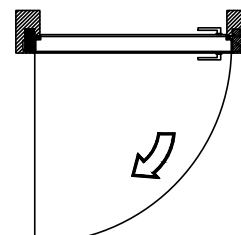

trage stanga

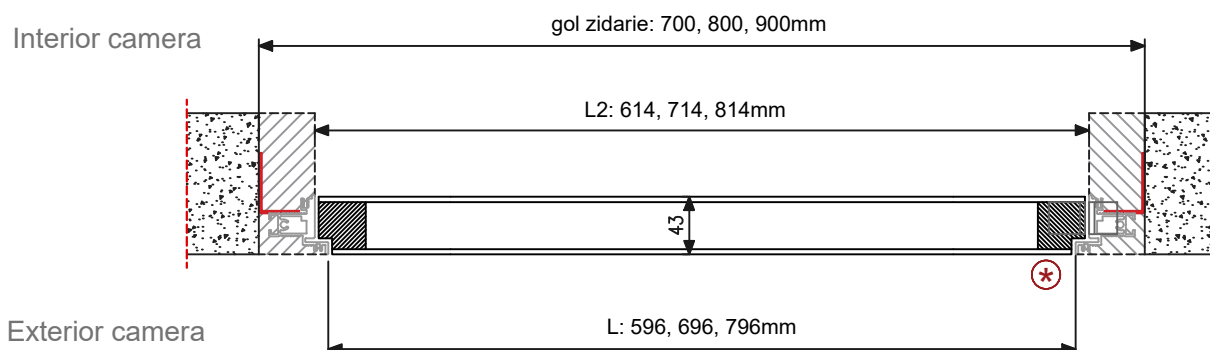

* toleranta planeitate ± 0.5 mm