

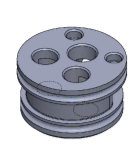









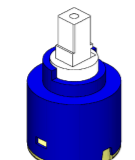
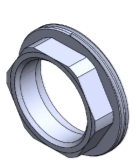

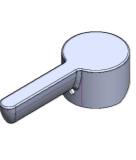

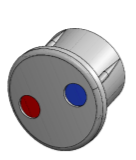
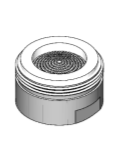





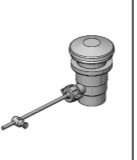

1	2	3	4	5	6	7	8	9	10	11	12	13	14	15	16	17	18	19	20	21	22	23	24	25	26
BODY	INNER BODY	O-RING	CARTRIDGE	CARTRIDGE NUT	CARTRIDGE CAP	HANDLE	SET SCREW	INDEX	AERATOR	BASE	BASE O-RING	FIXING KIT	FLEXIBLE HOSE	POP UP WASTE ROD	POP UP WASTE ROD	POP UP WASTE BODY	SINGLE BOX	MULTIPLE BOX	SEPERATOR	INSTRUCTION SHEET	WARRANTY	WARRANTY CARD	SECURITY LABEL	PRODUCER LABEL	BAG
																									
GÖVDE	İÇ GÖVDE	O-RING	KARTUŞ	TESPİT BİLEZİĞİ	KARTUŞ KAPAĞI	KUMANDA KOLU	SETİSKÜR	İNDEKS	PERLATÖR	ALT TABAN	ALT TABAN O-RING	ALT BAĞLANTI TAKIMI	FLEX HORTUM	SİFON ÇUBUĞU	SİFON ÇUBUĞU	SİFON GÖVDESİ	KUTU	KOLI	SEPERATÖR	KULLANIM KILAVUZU	GARANTİ BELGESİ	GARANTİ KARTI	GÜVENLİK ETİKETİ	ÜRETİCİ ETİKETİ	TORBA
2016904.02	7026252.00	2010350.00	7026256.00	2030107.00	2030116.02	2016952.02	2010158.05	A543837307	2020282.02	2010155.02	2010156.00	2010388.00	2016351.00	2010264.00	2010263.00	2010262.00	KUT.0000262	KOLI.0000052	SEP.0000001	KTP.0000246	A523010907	KTP.0000245	A543952407	ETKT.1000130	TORB.0000052



TOLERANCES TO APPLY - IF NOT SPECIFIED
Aksi belirtilmedikçe uygulanacak toleranslar aşağıdaki gibidir.

1000 < x	+1,2	-0,3
300 < x < 1000	+0,3	-0,8
100 < x < 300	+0,2	-0,5
30 < x < 100	+0,15	-0,3
8 < x < 30	+0,1	-0,2
x < 8	+0,05	-0,1

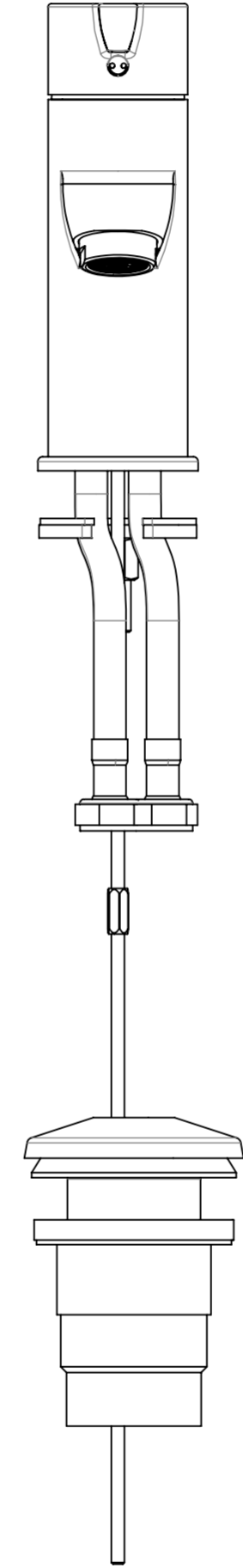
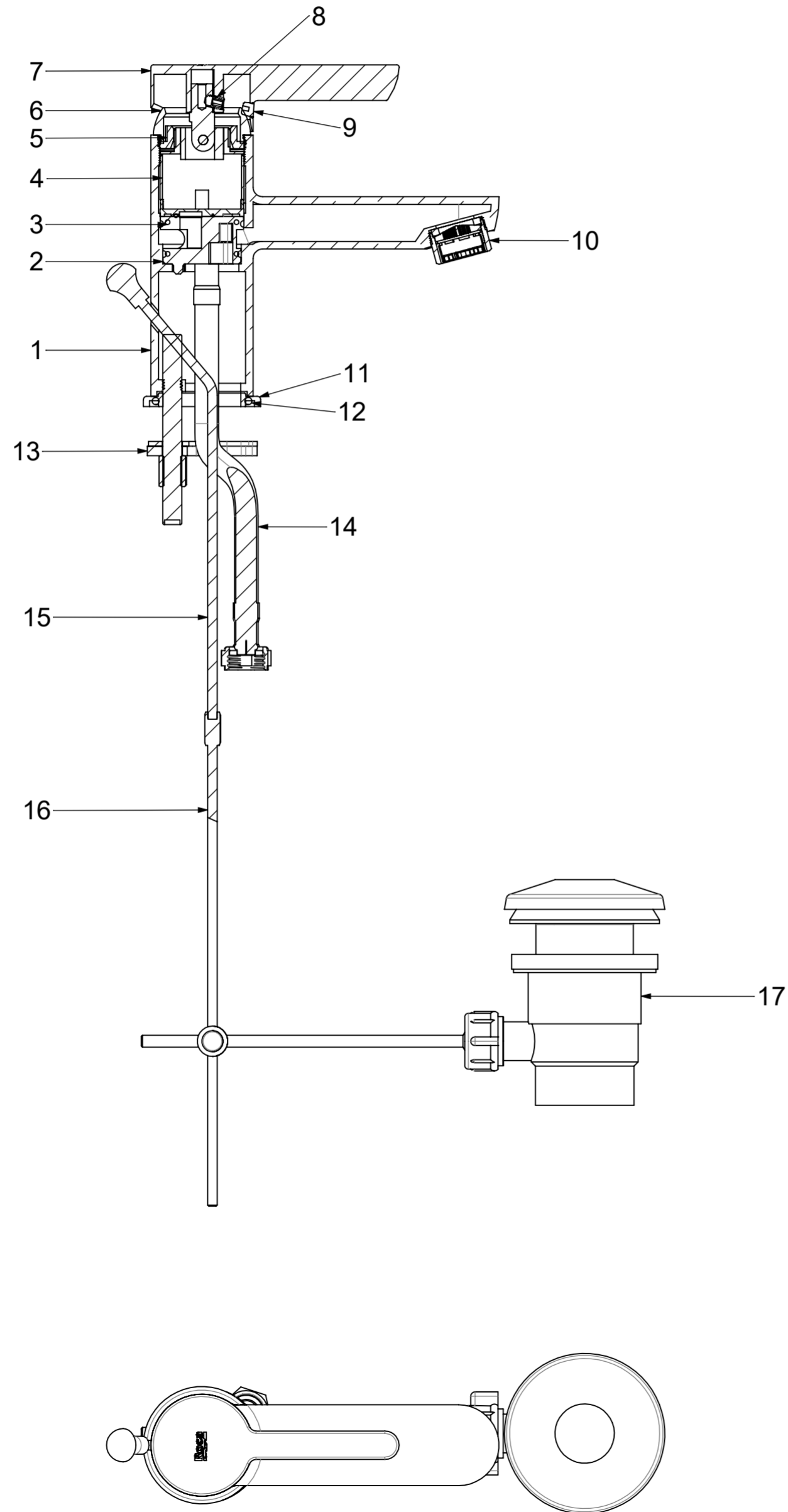
Fine Quality
Medium Quality
Coarse Quality

SURFACE QUALITY / YÜZEY İŞLEM KALİTELERİ

3,2	3,2 Mikron max. pürüz.
0,8	Gözle görülmeyen pürüz.
12,5	12,5 Mikron max. pürüzlülük

İşlemesiz

Version	Revision / Revizyon	Date/Tarih	Name/İsm	MATERIAL: MALZEME:		
Created by: Oluşturan:	Date Tarih	Name İsm	ROCA TR BANYO A.Ş.	SURFACE AREA: YÜZEY ALANI:		
Checked by: Kontrol:	16.01.2018	Y.SENSES		SAONA LAVABO BATARYASI (SİFON)	SCALE Ölçek	
FINISHING: Kaplama:	16.01.2018	S.CETINKAYA		SAONA BASIN MIXER WITH POP UP WASTE	1:2	
WEIGHT: Ağırlık:	.02			A5A307AC0K	VERSION	SHEET N° Sayfa N°
						1/3

TOLERANCES TO APPLY - IF NOT SPECIFIED
Aksi belirtilmedikçe uygulanacak toleranslar cetveli

1000 > x	300 > x ≤ 1000	100 > x ≤ 300	30 > x ≤ 100	8 > x ≤ 30	1 > x ≤ 8	1000 > x
+0,3	+0,3	+0,2	+0,15	+0,1	+0,05	1000 > x
-0,3	-0,3	-0,2	-0,15	-0,1	-0,05	300 > x ≤ 1000
+1,2	+1,2	+0,5	+0,3	+0,2	+0,1	100 > x ≤ 300
-1,2	-1,2	-0,8	-0,3	-0,2	-0,1	30 > x ≤ 100
+3	+3	+1,2	+0,8	+0,5	+0,1	8 > x ≤ 30
-3	-3	-1,2	-0,8	-0,5	-0,1	1 > x ≤ 8

SURFACE QUALITY / YÜZEY İŞLEM KALİTELERİ
İşlemesiz 3,2 Mikron max. pürüz.
İşlemesiz 0,8 Mikron max. pürüz.
İşlemesiz 12,5 Mikron max. pürüzlülük Gözle görülmeyen pürüz.

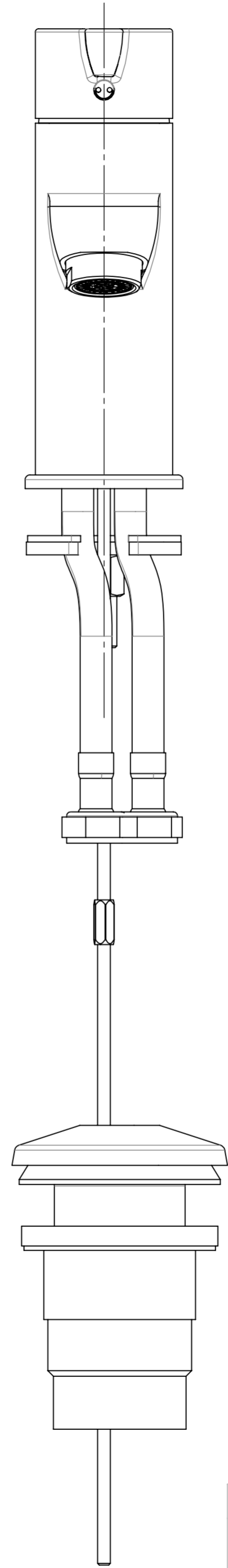
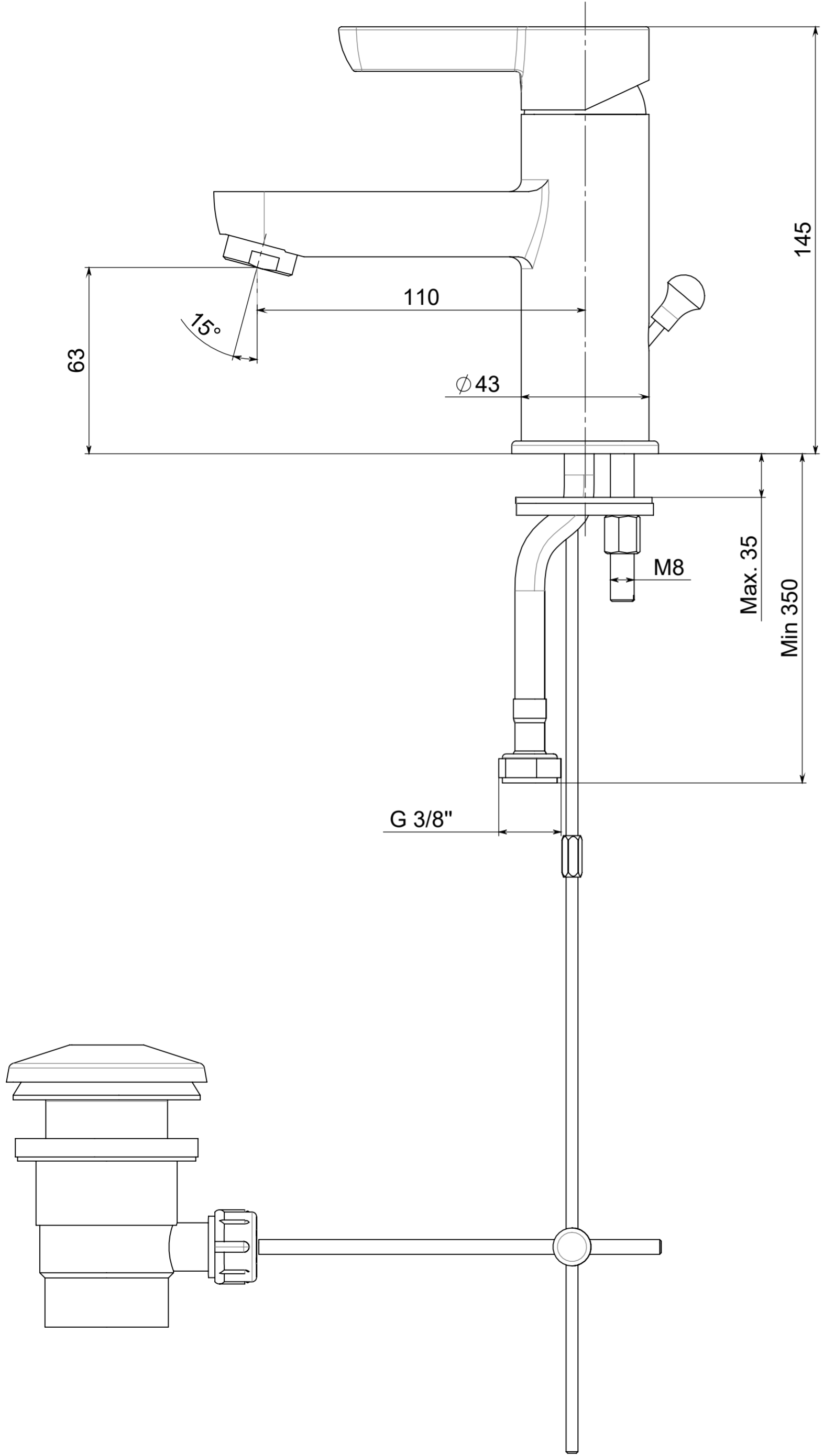

Version	Revision / Revizyon		Date/Tarih	Name/İsim	MATERIAL: MALZEME:
Created by: Oluşturan:	Date Tarih	Name İsim	ROCA TR BANYO A.Ş.		SURFACE AREA: YÜZEY ALANI:
Checked by: Kontrol:	16.01.2018	Y.SENSES			SAONA LAVABO BATARYASI (SİFON)
FINISHING: Kaplama:	16.01.2018	S.CETINKAYA	SAONA BASIN MIXER WITH POP UP WASTE		SCALE Ölçek
WEIGHT: Ağırlık:	.02		A5A307AC0K		3:4
				VERSION	SHEET N° Sayfa N°
					2/3

TOLERANCES TO APPLY - IF NOT SPECIFIED
Aksi belirtilmedikçe uygulanacak toleranslar cetveli

1000 > x	300 > x ≤ 1000	100 > x ≤ 300	30 > x ≤ 100	8 > x ≤ 30	1 > x ≤ 8
+0,3 -0,3	+0,3 -0,3	+0,2 -0,2	+0,15 -0,15	+0,1 -0,1	+0,05 -0,05
+1,2 -1,2	+0,8 -0,8	+0,5 -0,5	+0,3 -0,3	+0,2 -0,2	+0,1 -0,1

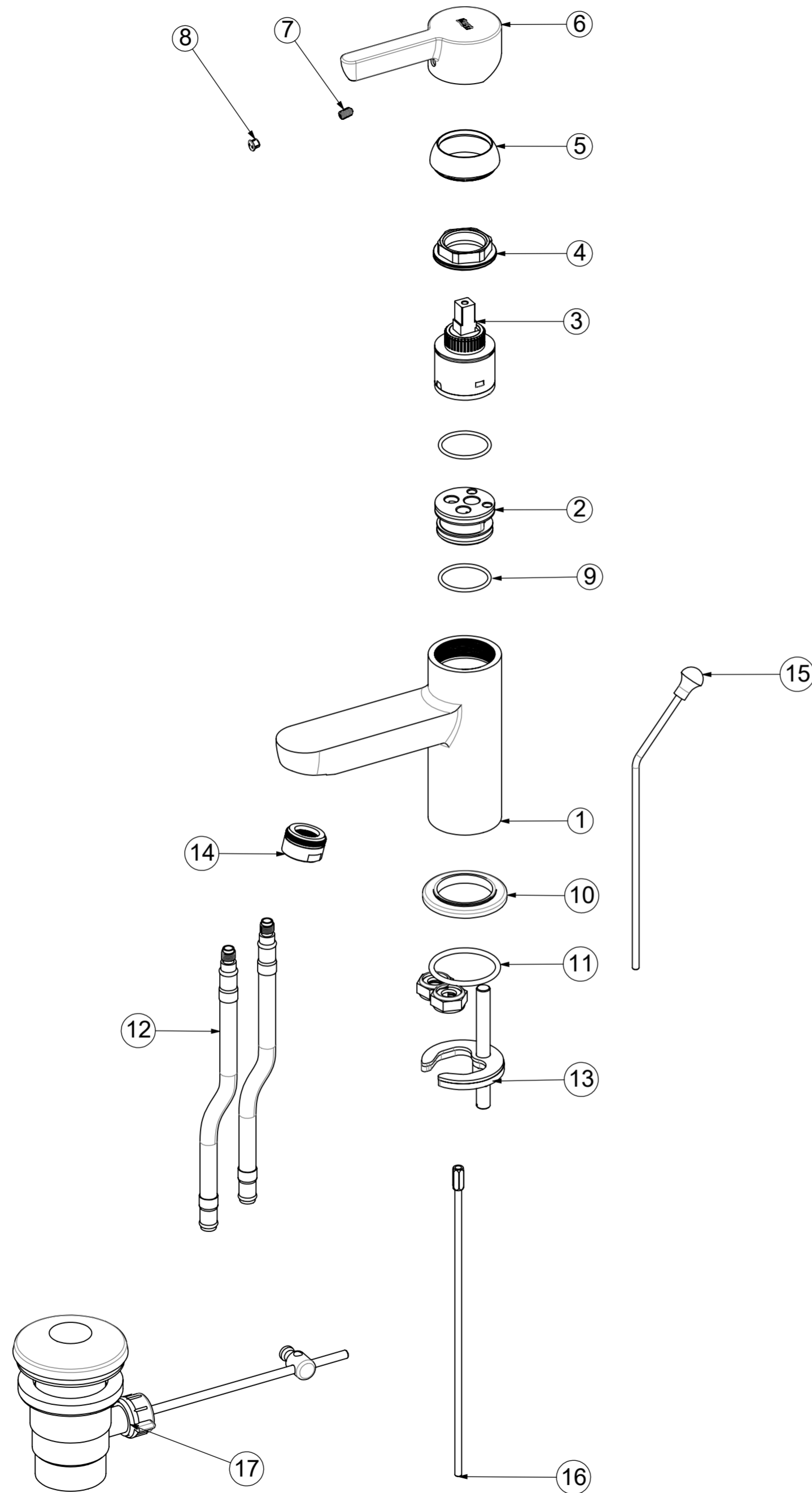
SURFACE QUALITY / YÜZEY İŞLEM KALİTELERİ
İşlemesiz
3,2 Mikron max. pürüz.
0,8
12,5 Mikron max. pürüzlülük
Gözle görülmeyen pürüz.

POS NO	PART CODE / PARÇA KODU	TÜRKÇE TANIM	QTY / MİKTAR
1	2016904.02	LEGNA LAVABO GÖVDE (SİFON)	1
2	7026252.00	DANSKAR PLASTİK İÇ GÖVDE M8x1	1
3	7026256.00	SEDAL Ø35 COLD START CARTRIDGE	1
4	2030107.00	KARTUŞ TESPİT BİLEZİĞİ	1
5	2030116.02	M37X1,5 KARTUŞ KAPAĞI	1
6	2016952.02	KUMANDA KOLU SAONA 35(HANDLE)	1
7	2010158.05	M5x8 SETSKUR	1
8	A543837307	INDEX KIRMIZI-MAVİ Ø6,5X5,1	1
9	2010350.00	İC GOVDE O-RING Ø27 X Ø2	2
10	2010155.02	Ø35 LAVABO ALT TABAN	1
11	2010156.00	Ø35 ALT TABAN GÖVDE O-RING	1
12	2016351.00	M8x1 3/8" 42.5 cm EN 13618 FLEX HORTUM	2
13	2010388	M8 X 60 BAĞLANTI TAKIMI	1
14	2020282.02	40.2051.03301 M24x1 PERLATÖR 5L./MIN HONEYCOMB	1
15	2010264.00	VINZIA POP-UP WASTE ÜST ÇUBUK	1
16	2010263.00	VINZIA POP-UP WASTE ALT ÇUBUK	1
17	2010262.00	VINZIA POP-UP WASTE GÖVDE	1

Version	Revision / Revizyon	Date/Tarih	Name/İsm	MATERIAL: MALZEME:
Created by: Oluşturan:	16.01.2018	Y.SENSES	ROCA TR BANYO A.Ş.	SURFACE AREA: YÜZEY ALANI:
Checked by: Kontrol:	16.01.2018	S.CETINKAYA		SAONA LAVABO BATARYASI (SİFON)
FINISHING: Kaplama:	.02			SAONA BASIN MIXER WITH POP UP WASTE
WEIGHT: Ağırlık:				A5A307AC0K
				VERSION
				SHEET N° Sayfa N°
				3/3